

PRODUCT NAME: SB-125/ 150- EXPLOSION-PROOFSOUNDER/HORN & BEACON DOC NO.: EX-TECH-SIG-SAS-12-SB125-150-TM-EN-REV06-10.08.16.IE

**EXPLOSION PROOF SOUNDER/HORN & BEACON**



II 2GD Exd IIC T4/T5/T6 Gb, IP66

Ex tb IIIC Txxx EPL Gb, Db

**EX-TECH SIGNALLING SAS**

**SB-125/ 150 EXPLOSIONPROOF SOUNDER/HORN & BEACON**

**TECHNICAL MANUAL**



Type :			
CE 0470	Ex II 2 GD	ATEX 13 NEMKO 1566X	
Ex d IIC T4 Gb	IP 66	IECEX, NEM 13.0036X	
Ex tb IIIC T135°C		CNEEx 10.2114X	
T. amb: -40°C < Ta < +70°C		P	20 Watt max
		U	<input type="checkbox"/> VDC <input type="checkbox"/> AC50/60Hz
		Serial N° :	
WARNING - DO NOT OPEN WHEN AN EXPLOSIVE ATMOSPHERE IS PRESENT			
		<b>Ex-tech Signalling SAS</b>	
Ex-tech Signalling SAS, Champniers, France - www.ex-tech.no			

Alternative T class:

1:  
Ex d IIC T5 Gb  
Ex tb IIC T100°C  
T.amb :-40°C <Ta<+60°C

2 :  
Ex d IIC T6 Gb  
Ex tb IIIC T85°C  
T.amb : -40°C <TA<+55°C

Please note that every care has been taken to ensure the accuracy of our technical manual. We do not, however, accept responsibility for damage, loss or expense resulting from any error or omission. We reserve the right to make alterations in line with technical advances and industry standards.

## 1.0 INTRODUCTION

SB-125/ 150 series Explosion-proof Sounder/Horn & Beacon is designed according to EN/ IEC 60079-0, EN/ IEC 60079-1 and EN/ IEC 60079-31 standards. Enclosure material is Stainless Steel (SB 125) or GRP (BC 150). This product is certified for use and installation in Zone 1 and Zone 2 areas with gases groups of IIA, IIB, IIC and temperature classification of T4-T6. It specially applies to Oil & Gas, Offshore Platform, Chemical, Petrochemical Refinery and Marine Industries etc. Users can choose from single or combination types. The design of 3 in 1 sounder, loudspeaker and beacon is unique. According to user control system, 4 stages of alarm tones can be sent out, from less critical stage (stage 1) to the most critical stage (stage 4). 64 tones are selectable. Tone can be preset during installation. At the same time, four stages of alarm light can also be sent out.

## 2.0 EXPLOSION-PROOF LABELING

All products have a rating label, which carries the following important information:

Product order no.:

e.g. **SB1251RX05DCNNAR**

Input voltage: up to 48V DC or 100-254V AC

Code:

Ex d IIC Txx Gb

Ex tb IIIC Txx

ATEX Marking:

Gas Group and Category: II 2GD

CE Mark:



Warning: **DO NOT OPEN WHEN AN EXPLOSIVE GAS ATMOSPHERE IS PRESENT**

Note; exact information is given on the actual label, ref also example on page 1

## 3.0 TYPE APPROVAL STANDARD

The SB series have been approved to the following standards:

EN/IEC 60079-0:2008 General Requirements

EN/ IEC 60079-1:2009

Flameproof Enclosure 'd'

EN/IEC 60079-31, Dust

## 4.0 ZONES, GASGROUP, CATEGORY AND TEMPERATURE CLASSIFICATION

The SB series products have been certified Ex d IIC T4-T6. This means that the units can be installed in locations with the following conditions:

### Area Classification:

**Zone 1:** Explosive gas air mixture likely to occur in normal operation.

**Zone 2:** Explosive gas air mixture not likely to occur, and if it does, it will only exist for a short time.

**Gas Groupings:** Group IIA Propane Group

IIB Ethylene Group

IIC Hydrogen and Acetylene

**Equipment Category:**

2GD

EPL; Gb/ Db

**Temperature Range:** See label,ref page 1

## 5.0 INSTALLATION

### General Requirement

Selection, Installation, Maintenance and repair of electrical apparatus for use in potentially explosive atmosphere should be done in according to IEC/ EN 6079-14/ -17/ -19 . Product installation must be carried out in accordance with any local codes that may apply and should only be carried out by a competent electrical engineer.

### Location

The location of the unit should be made with due regard to

the area over which both the sounder and beacon warning signal must be audible and visible. The unit should only be fixed to services that can carry the weight of the unit.

**Mounting**

**SINGLE UNIT**

The single unit only comes with one beacon and can be mounted via a 'U' shaped stainless steel bracket. It can be done using one 12mm diameter and two 8.5mm diameter bolt holes in the center of the bracket (See Fig 1). The alignment and positions can be adjusted by loosening the two M8 screws, which fastened the stainless steel bracket to the sounder. The sounder should be positioned such that dust, debris or water cannot enter into the horn opening.

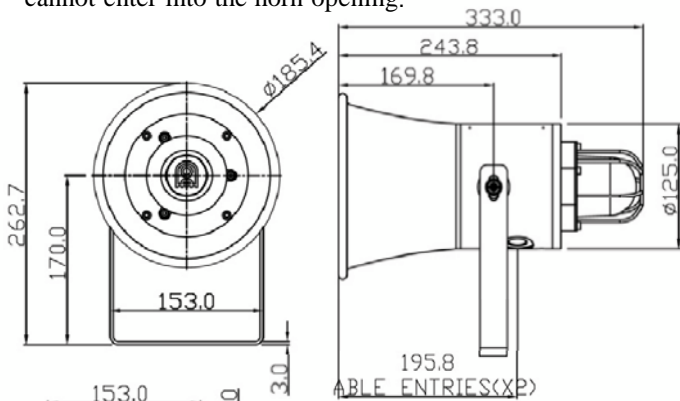

**Fig 1**

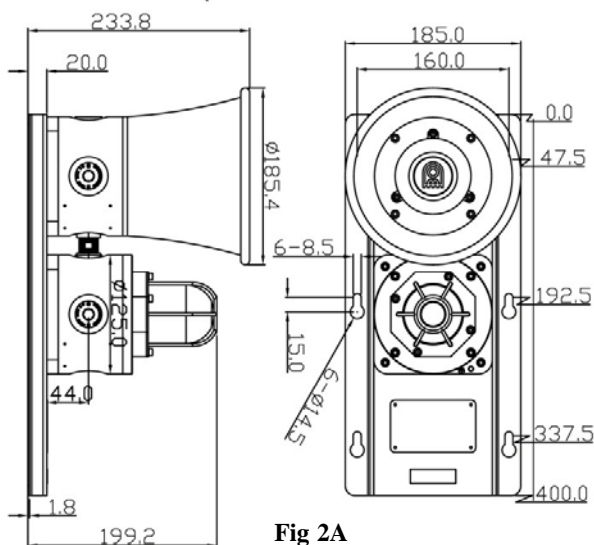

**Fig 2A**

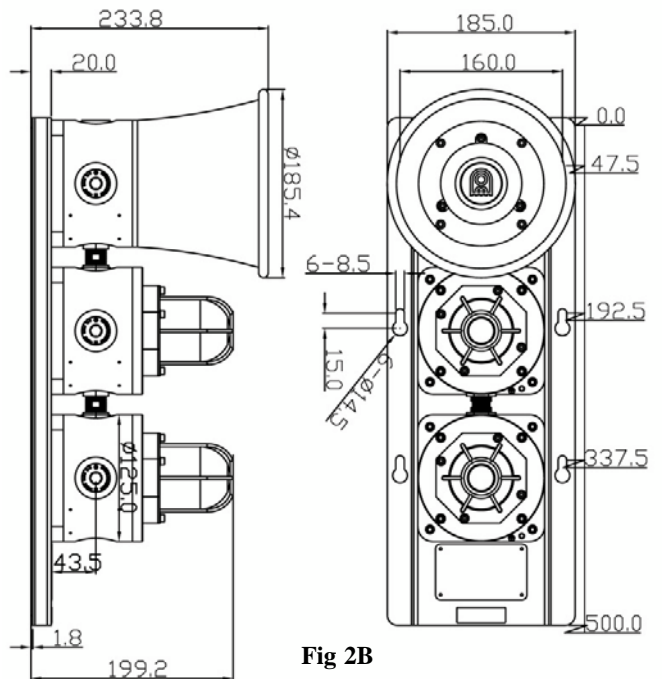

**Fig 2B**

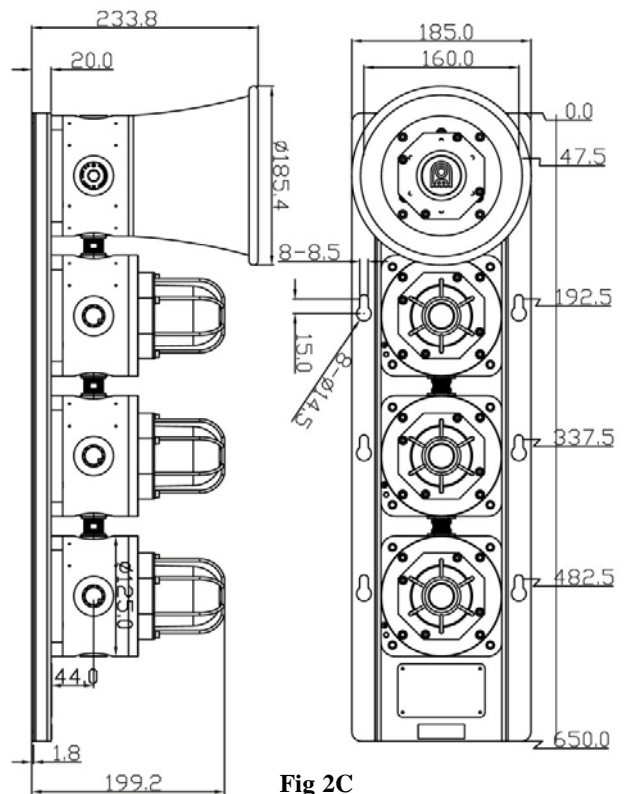

**Fig 2C**

**COMBINED UNIT**

As for the combined unit it come with either one or two or three beacons and can be mounted on a vertical surface via a stainless steel mounting plate (see Fig 2A/B/C). The fixing holes on the mounting plate are designed to fit M8 Allen Screw only. The diameter is 9mm. Use of stainless

steel fastener is recommended by Ex-tech Signalling SAS.

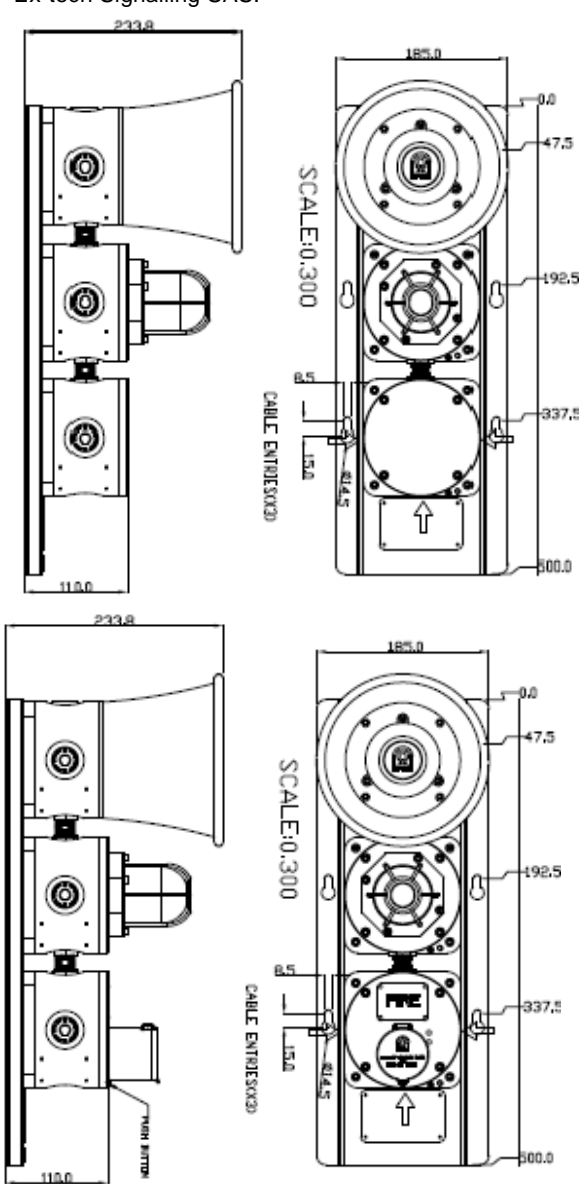

Fig 2D

## 6.0 WIRING

### General Requirement

EX-TECH SIGNALLING SAS recommends that all cables and cores should be fully identified (suggest using cable from 2.0 to 2.5 mm<sup>2</sup>).

Ensure that all nuts, bolts and screws are secured. Ensure that only the right and certified cable glands are used and earthed correctly. Ensure that only the right and certified stopping plugs are used to blank off unused gland entry points. In order to maintain the IP rating of the product, we

recommend SS316L for this application. **Cable Connection**

The cable connection is connected with the terminal blocks on the electronic **PCB** assembly located in the flameproof enclosure of the **Beacon Component** (For Single Unit, See Fig 3A); or assembly located in the bottom unit which can be **Beacon Component** ( For Combined Unit, See Fig 3B) or Push Button or Junction Box. Cable connection should be carried out in accordance with relevant technical requirement.

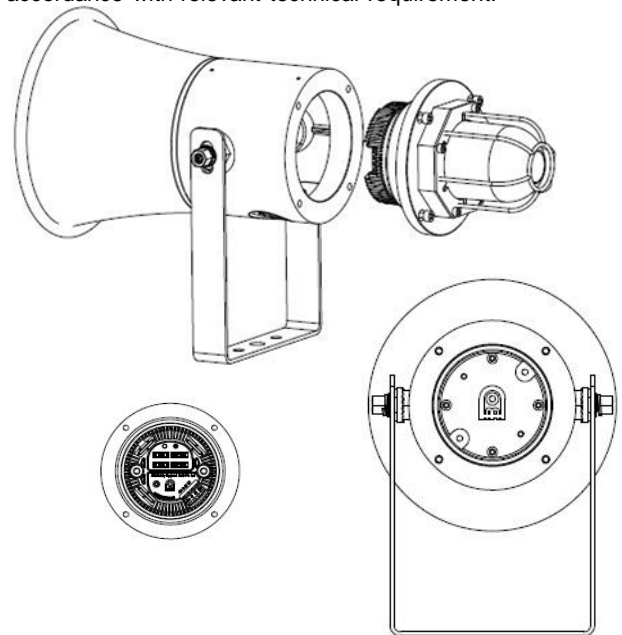

Fig 3A Single Unit

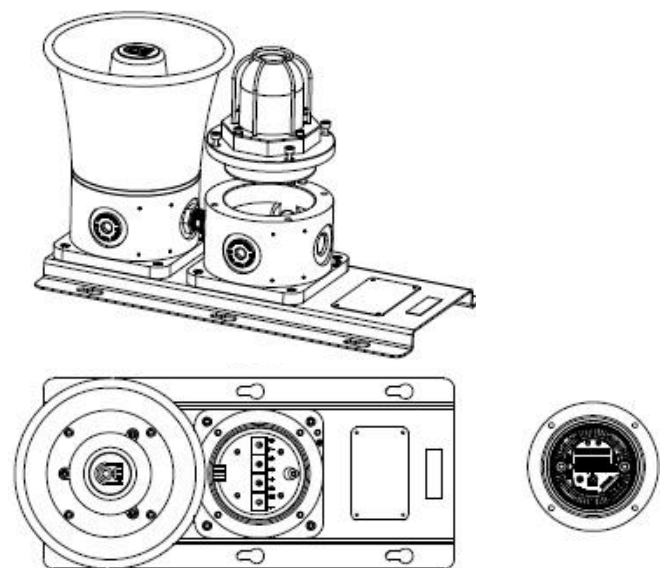

Fig 3B Combined Unit

**Remove End Cover (Beacon Component)**

**CAUTION:** Before removing the cover, ensure the power to the product is isolated. Unscrew the 4 (SB 125) or 6 (SB 150) M5 retained hex socket head screws of the **Beacon Component** (See Fig 3A/B) to open the End cover. Twist the cover gently clockwise and anti-clockwise, whilst pulling away from the base, until it comes off.

**Note; it recommended to open one blind plug to avoid internal vacuum in the unit.**

This will release the cover from the base and allow the cover to hang on the retaining wire strap. Before replacing the cover, check that the flameproof joints are clean and not damaged, the gasket is still retained in its groove.

As lubrication / grease for the flameproof joint, a thin film of Acid free Vaseline (soap-thickened mineral oils) or mineral oil can be used, excessive lubrication / grease shall be removed before assembling.

Reinstall the cover in similar way, but operate in reverse manner as above.

**Recommended Bolt Torque for M5 lid screws are 4.5 Nm**

**Power Supply**  
Up to 48v DC  
**PCB WIRING TERMINALS**  
**SINGLE UNIT ( DC ) LED**  
**Type:** (See Fig 4)

S2: Switch 2 for alarm stage selection

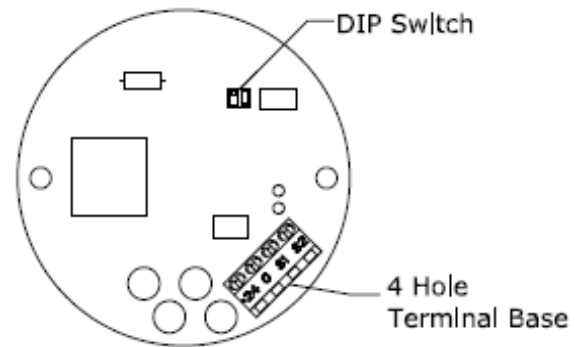

Fig 5

**Sounder:** (See Fig 6)

- 0: Power input DC 0/COM
- +24V: Power input DC 24V +
- S1: Switch 1 for alarm stage selection
- S2: Switch 2 for alarm stage selection

- 0: Power input DC 0/COM
- +24V: Power input DC 24V +
- S1: Switch 1 for alarm stage selection
- S2: Switch 2 for alarm stage selection

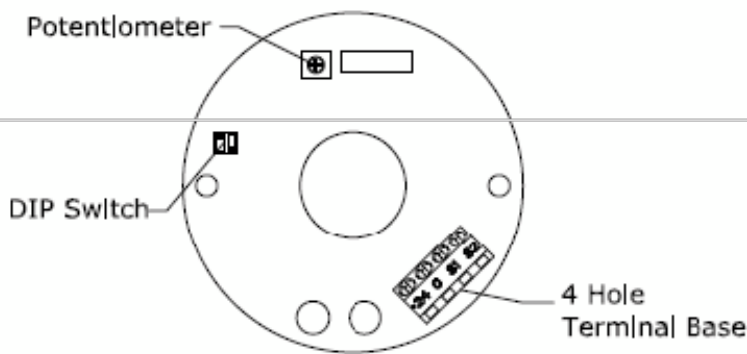

Fig 4

**Xenon Type:** (See Fig 5)

- 0: Power input DC 0/COM
- +24V: Power input DC 24V +
- S1: Switch 1 for alarm stage selection

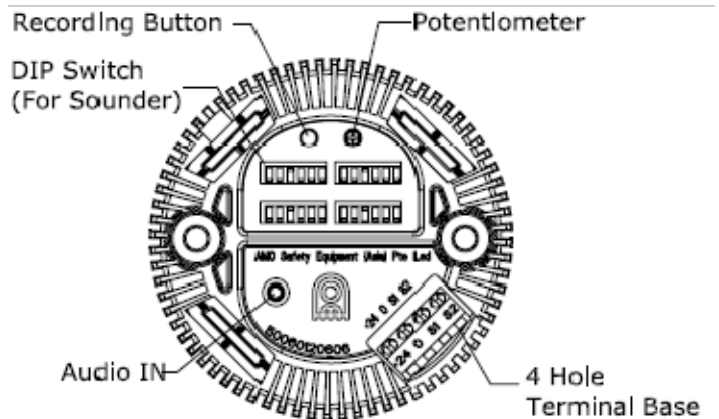

Fig 6

**COMBINED UNIT (24V DC)**

**LED Type:**

As same as above LED Type in Single Unit (See Fig4)

**Xenon Type:** (See Fig 7)

- 0: Power input DC 0/COM
- +24V: Power input DC 24V +
- S1: Switch 1 for alarm stage selection
- S2: Switch 2 for alarm stage selection



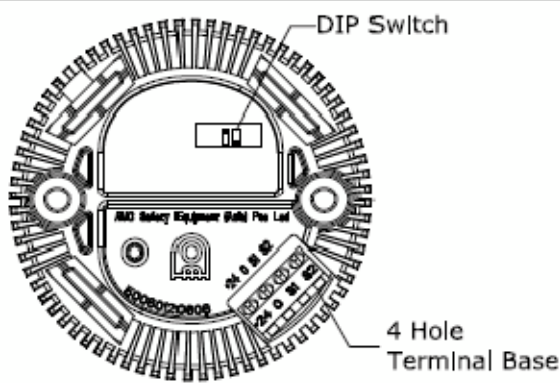

Fig 7

**LED Beacon**

The LED beacon provides flashing and rotary status to be selected. Use **DIP Switch** with 2 binary codes on the **LED Beacon PCB** to select flashing or rotary status (including steady status). Adjust the **Potentiometer** on the **LED Beacon PCB** (see Fig 4) for frequency adjustment. For fastest stage frequency, the potentiometer should be set to fully clockwise position.

**LED Status Selection Switch**

DIP Switch: ON=1, OFF=0

S1/S2: ON= Connect with 0/COM, OFF= Disconnect with 0/COM

DIP Switch			S1/S2	S1=OFF S2=OFF	S1=ON S2=OFF	S1=OFF S2=ON	S1=ON S2=ON
1 <sup>st</sup> DIP	2 <sup>nd</sup> DIP	3 <sup>rd</sup> DIP	Alarm Stage 1	Alarm Stage 2	Alarm Stage 3	Alarm Stage 4	Alarm Stage 4
0	0	0(1)	OFF	Flash 60 (75) times/min.	Flash 75 (90) times/min.	Steady	
1	0	0(1)	OFF	Rotary 60 (75) times/min	Rotary 75 (90) times/min	Steady	
0	1	0(1)	OFF	Triple Flash 60 (75) times/min.	Triple Flash 75 (90) times/min.	Triple Flash 100(120) times/min.	
1	1	0(1)	OFF	Flash &Rotary 60 (75) times/min	Flash &Rotary 75 (90) times/min	Flash &Rotary 100(120) times/min	

**Sounder:**

As same as above Sounder in Single Unit (See Fig 6)

**Four Alarm Stages**

DC Type:

Stage 1: apply power supply to 0/COM and +24V;

Stage 2: apply power supply to 0/COM, +24V and connect S1 to 0/COM;

Stage 3: apply power supply to 0/COM, +24V and connect S2 to 0/COM;

Stage 4: apply power supply to 0/COM, +24V and connect S1, S2 to 0/COM.

**7.0 TONE SELECTION**

The sounder of SB125 provides 64 tones to be selected for the 1st stage alarm. Four stages of alarm tones can be preset via switch on the Sounder PCB.

**Tone Selection Switch**

Use the four (4) DIP switches with 6 binary codes on the **Sounder PCB** to select tones (See Fig 6).

**Tone Selection Table (see attached table 1)**

**8.0 SOUNDER VOLUME CONTROL**

The SB125 has a volume control to adjust the output volume of the sounder component. To set the required output volume, adjust the potentiometer-VR1 on the PCB (See Fig 6). The potentiometer should be set to fully clockwise position if maximum output volume is needed.

**9.0 STATUS CHOSEN AND FLASHING FREQUENCY ADJUSTMENT**

**Xenon Beacon**

The Xenon Beacon provides flashing status

Use **DIP Switch** with 2 binary codes on the **Xenon Beacon PCB** (see Fig 5/7) for frequency adjustment.

**Xenon Beacon Flashing Frequency Adjustment**

DIP Switch: ON=1, OFF=0

S1/S2: ON= Connect to COM, OFF= Disconnect to COM

S1/S2 DIP Switch		S1 = OFF S2 = OFF	S1 = ON S2 = OFF	S1 = OFF S2 = ON	S1 = ON S2 = ON
1	2	Alarm Stage 1	Alarm Stage 2	Alarm Stage 3	Alarm Stage 4
1	1	OFF	60 times/min (1)	90 times/min (1)	120 times/min (1)
0	1	OFF	60 times/min (2)	60 times/min (3)	60 times/min (4)
1	0	OFF	60 times/min (3)	60 times/min (4)	60 times/min (5)
0	0	OFF	60 times/min (4)	60 times/min (5)	60 times/min (6)

All the value in () are the number of flash by time

### 10.0 CABLE GLAND

The SB125 series product has cable gland entries. Only cable glands approved for Ex 'd' applications can be used, which must be suitable for the type of cable being used and also meet the requirements of the Ex 'd' flameproof installation standard EN 60079-14.

**SAFETY WARNING:** If the SB125 is used at high ambient temperatures, i.e. over +40°C, then the cable entry temperature may exceed +70°C and therefore suitable heat resisting cable glands must be used, with a rated service temperature of at least 95°C.

If a high IP (Ingress Protection) rating is required, a suitable sealing washer must be fitted under the cable gland.

When only one cable entry is used, the other one must be closed with an Ex 'd' flameproof blanking plug, which must be suitably approved for the installation requirements.

### 11.0 END OF LINE MONITORING

An end of line monitoring diode or an end of line monitoring resistor can be connected across the 24V+ and 0 terminals. If an end of line monitoring resistor is used, it must have a maximum resistance value of 3k ohms and a minimum wattage of 0.5 Watts; or a minimum resistance value of 1.2k ohms and a maximum wattage of 2 Watts.

During working life of the product, little or no maintenance is required. SS316 is resistant to most of the acids, alkalis and chemicals.

If abnormal or unusual environmental conditions occur due to accident etc., visual inspection is recommended.

To avoid electrostatic charge build-up, only exterior of the product can be cleaned with a damp cloth.

If spare parts are required, these can be supplied by Ex-tech Signalling Company.

### 12.0 MAINTENANCE

If any failure occurs but not caused by human factor, the product can be returned to Ex-tech for free repair or replacement during warranty period.

### 13.0 CONDITIONS FOR SAFETY USE















































- i. This apparatus is suitable to be used only in ambient temperature as stated on the label:
- ii. Other than product manufacturer, painting and surface finishing are not permitted by the third party.
- iii. When used in dusty atmosphere, flameproof cable entry devices or stopping plugs have to be selected and installed carefully in order to maintain the IP rating (IP66/67) of the product.

#### Specific Condition for Use

Repair of the flameproof joints must be made in compliance with the structural specifications provided by the manufacturer. Repairs must not be made on the basis of values specified in tables 1 and 2 of EN/IEC 60079-1.

**Please contact Ex-Tech Signalling for further details**

**Attached Table 1: Tone Selection Table**

ITEM	DESCRIPTION				Max dB	SW1,SW2,SW3,SW4
Tone	Frequency	Tone Description	Tone Application	Waveform	(DB)@1M	Bit 123456
01	300Hz	Continuous			112	000000
02	340Hz	Continuous			112	100000
03	440Hz	Continuous			112	010000
04	554Hz	Continuous			113	110000
05	660Hz	Continuous	All-clear, Sweden		111	001000
06	800Hz	Continuous			113	101000
07	1000Hz	Continuous	PFEER Toxic Gas		117	011000
08	1200Hz	Continuous			114	111000
09	2000Hz	Continuous			113	000100
10	2400Hz	Continuous			111	100100
11	2850Hz	Continuous			112	010100
12	420Hz@0.625 sec	intermittent	Australian, AS2220		107	110100
13	544Hz@0.875 sec	intermittent			112	001100
14	660Hz@150ms on,150ms off	intermittent	Swedish Fire Alarm		108	101100
15	660Hz@1.8sec on,1.8sec off	intermittent	Swedish Fire Alarm		112	011100
16	745Hz@500ms on,500ms off	intermittent			110	111100
17	800Hz@250ms on,250ms off	intermittent			110	000010
18	800Hz@250ms on,1sec off	intermittent			108	100010
19	1000Hz@250ms on,250ms off	intermittent			113	010010
20	1000Hz@500ms on,500ms off	intermittent	Back-up Alarm(LF)		113	110010
21	1000Hz@250ms on,1sec off	intermittent			113	001010
22	1000Hz@1sec on,1sec off	intermittent	PFEER Gen, Alarm		113	101010
23	2400Hz@250ms on,250ms off	intermittent			109	011010
24	2400Hz@500ms on,500ms off	intermittent			108	111010
25	2850Hz@1sec on,1sec off	intermittent	Back-up Alarm(HF)		109	000110
26	2850Hz@150ms on,100ms off	intermittent	Pelican Crossing		109	100110
27	970Hz@0.5sec on/0.5sec off,1.5sec off	3 Pulses			113	010110
28	2850Hz@0.5sec on/0.5sec off,1.5sec off	3 Pulses			109	110110
29	700Hz@6sec on/12sec off	intermittent	Pre-vital mess, Sweden		113	001110
30	700Hz@2sec on/2sec off	intermittent	Air-raid, Sweden		113	101110
31	700Hz@125ms on/125ms off	intermittent	Local warning, Sweden		113	011110
32	720Hz@0.7sec on/0.3sec off	intermittent	Industrial alarm, Germany		113	111110
33	544Hz/440Hz@500ms	Alternating	Swedish Fire Alarm		109	000001
34	544Hz/440Hz@100ms/400ms	Alternating	AFNOR,NFS 32-001		109	100001
35	544Hz/440Hz@1sec	Alternating	Turn-out, Sweden		108	010001
36	800Hz/1000Hz@125ms	Alternating	Increased Urgency		112	110001
37	2400Hz/2900Hz@125ms	Alternating	Security Deterrent		108	001001
38	800Hz/1000Hz@250ms	Alternating	Fire Alarms		112	101001
39	800Hz/1000Hz@580ms	Alternating			112	011001
40	1000Hz/2000Hz@500ms	Alternating			112	111001
41	2400Hz/2900Hz@250ms	Alternating	Security Alarms		108	000101
42	500Hz--1000Hz@6Hz	Fast whoop			111	100101
43	500Hz--1200Hz@0.3Hz	Sweeping			110	010101
44	660Hz--1200Hz@1Hz	Sweeping			109	110101
45	800Hz--1000Hz@1Hz	Med Sweeping(LF)			109	001101
46	800Hz--1000Hz@7Hz	Fast Sweeping(LF)			109	101101
47	2400Hz--2900Hz@1Hz	Sweeping			108	011101
48	2400Hz--2900Hz@7Hz	Fast Sweeping			108	111101
49	800Hz--1000Hz@50Hz	Low Freq Buzz	Buzz		108	000011
50	2400Hz--2900Hz@50Hz	High Freq Buzz	Buzz		108	100011
51	500Hz--1200Hz@2.5sec  0.5sec	Slow Whoop			110	010011
52	500Hz--1200Hz@4.25sec , 0.25sec	Slow Whoop	Evacuation,Netherlands,Australian		110	110011
53	1200Hz--500Hz@1Hz	Reverse sweeping	Prepare to Abandon Platform		110	001011
54	1400Hz--1600Hz@1sec , 0.5sec	sweeping	NFC 48-256		110	101011
55	2850Hz	Fast Shake	Bell		106	011011
56	800Hz/660Hz	Tow tone chime	Int'l evacuation alarm		110	111011
57	800Hz/1000Hz	ISO 8201 Evacuation	Int'l evacuation alarm		110	000111
58	250Hz--1200Hz	Motor Siren-slow rise			112	100111
59	250Hz--800Hz	Motor Siren-slow rise			113	010111
60	250Hz--2400Hz	Motor Siren-slow rise	Industrial alarm, Germany		108	110111
61	Client Spare recording	20 or 10 Sec				001111
62	Client Spare recording	20 or 15 Sec				101111
63	Client Spare recording	20 or 25 Sec				011111
64	Client Spare recording	20 or 30 Sec				111111



**EX-TECH SIGNALLING SAS.**

**ZA Les Montagnes**

**355 rue de la Génoise**

**16430 CHAMPNIERS (France)**

**Tel: +33 5 45 61 81 68**

**Fax: +33 5 45 23 29 46**

**Website: [www.ex-tech.no](http://www.ex-tech.no)**

**E-mail: [sales.signalling@ex-tech.no](mailto:sales.signalling@ex-tech.no)**

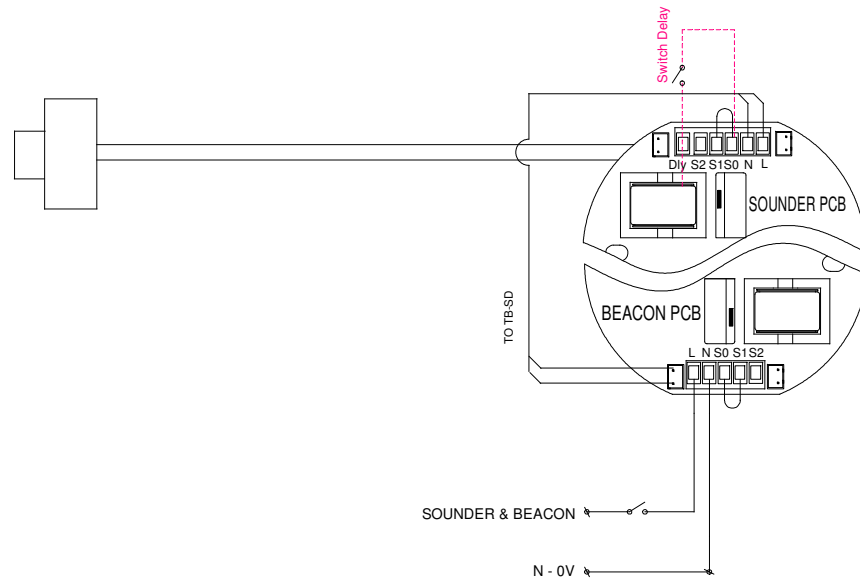
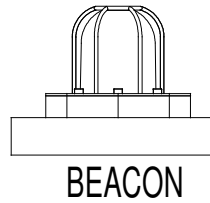
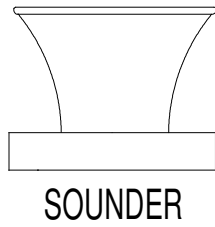

**WIRING METHOD**

Factory default setting

1. S0 and S1 are connected (default stage 1 alarm output)
2. Connect power supply line to terminals "L" and "N"
3. The unit will alarm (default stage 1 alarm output) when power is on
4. By default, the beacon and the sounder are setup to work simultaneously. By removing the wiring TO TB-SD between the two PCB Cards, you can connect separately the beacon and the sounder.

Factory default setting

1. Connect SW-S1 to S0 for stage 1 alarm output  
Connect SW-S2 to S0 for stage 2 alarm output  
Connect SW-S1/SW-S2 to S0 for stage 3 alarm output
2. The Stage 1 is set on DIP SW1  
The Stage 2 is set on DIP SW2  
The Stage 3 is set on DIP SW3
3. Connect SW-Dly to S0 for Alarm Pause delay work

PLEASE REFER TO OUR PRODUCT TECHNICAL MANUAL FOR MORE DETAILS.

**Cable Selection**

Please select suitable size cable according to the distance between control room & the terminals and the quantity of equipments used.

Normal size for AC power supply cable L & N is 1.5mm<sup>2</sup>

Normal size for DC power supply cable L & N is 2.5 mm<sup>2</sup>

Please select the quantity of control cables according to the actual requirement. Normal size for control cable is 1mm<sup>2</sup>.

02 - 16/11/2016	Mise à jour				
01 - 08/02/2016	Ajout d'un Shunt				
00 - 21/10/2015	Création				
Revision - date	Reason				
Material				Size : A3	
Treatment					
Specifications					
Drawing part		Scale : 1 : 1	Project / N° PO		Dossier
WIRING DIAGRAM SB100/125		Drawn by : P. TRAUMAT	-		-
		Date : 01/10/2015	N° Drawing		Index
			SB100/125		Folio
			02		1/1